

► **modulex**®

Leading the way



Ariadne

10" PNG Ariadne Panel

Data Sheet

General Information

The following pages show technical drawings of each sign variant, including electrical specifications and optional building into wall. At the end of the document the wiring details, weight, mounting details as well as service and maintenance are described.

10" Ariadne panel can only be used in combination with an Ariadne application running on www.m-sign.ariadne.info or an application installed on a local server. The panel updates the information displayed by automatically calling the application. This process is identical with a standard web access from an Internet browser and the protocol used is standard HTTP.

Throughout this document measurements will be given in both millimetres and inches. The metric measurements are exact whereas the English standard is calculated and therefore shown in brackets: 25.4 [1.00]

10" Ariadne Panel Version

The 10" Ariadne panel exists in a flat version. It can be configured with and without static panels. Measurements and possible panel configurations will appear from the following pages.

Contents:

General Information.....	2
10" Ariadne Panel Version	2
Sign Types within the Ariadne 10" Assortment	3
Ariadne Flat Front.....	4
Ariadne Flat Front with Top Panel.....	5
Ariadne Flat Front with Top and Bottom Panel	6
Wiring details for 10" Wall Sign	7
Weight of Components.....	9
Mounting Details.....	10
Service and Maintenance.....	10

Sign Types within the Ariadne 10" PNG Assortment:

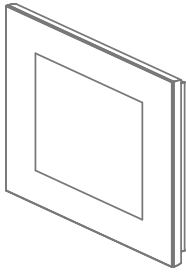

10" flat front
Drawing page 4
Wiring page 10

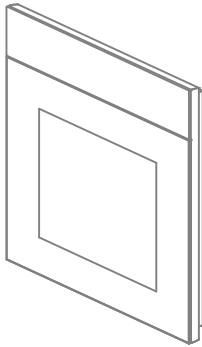

10" flat front with top panel
Drawing page 6
Wiring page 10

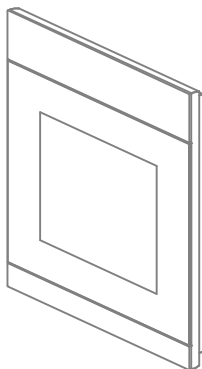

10" flat front with top and bottom panel
Drawing page 8
Wiring page 10

Ariadne Flat Front

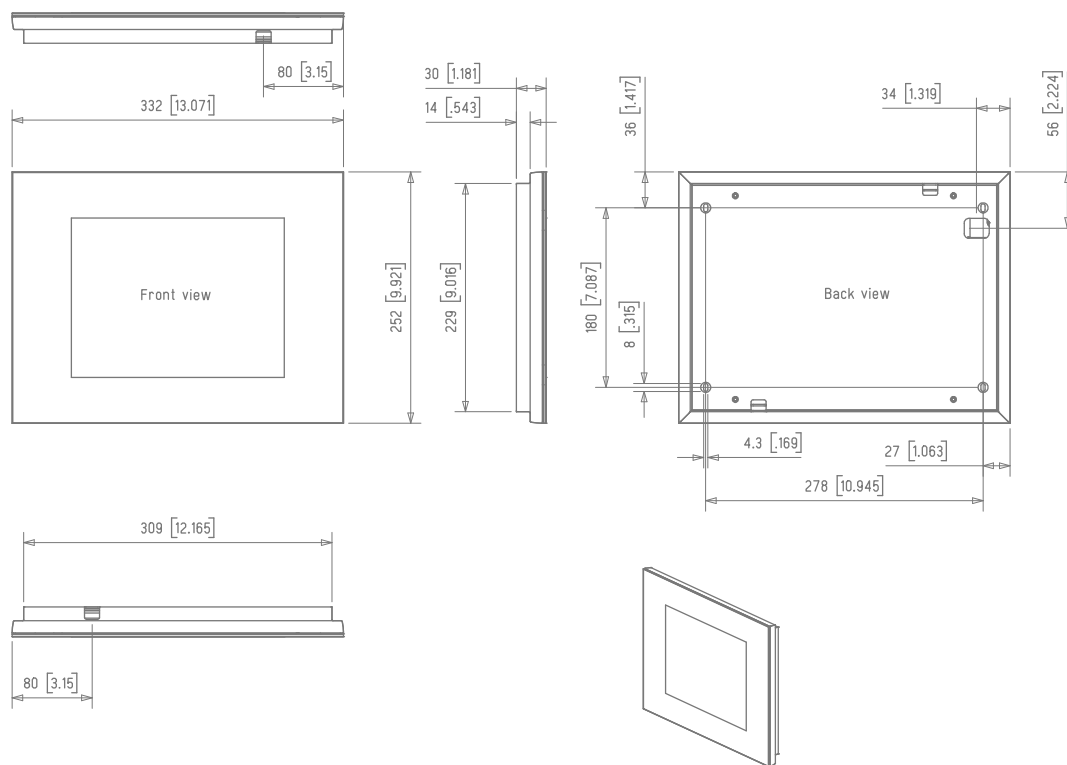

Built into wall (option - no extra parts needed):

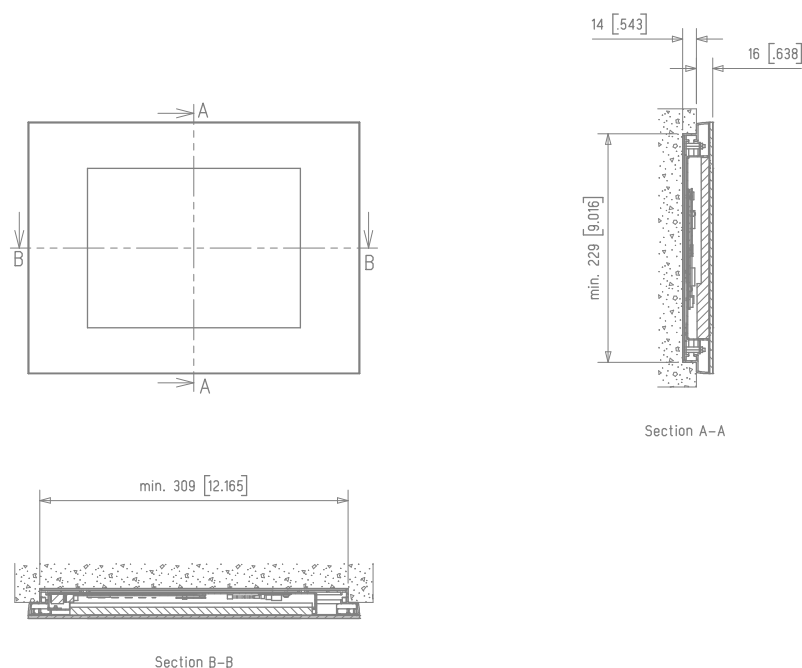

Ariadne Flat Front with Top Panel

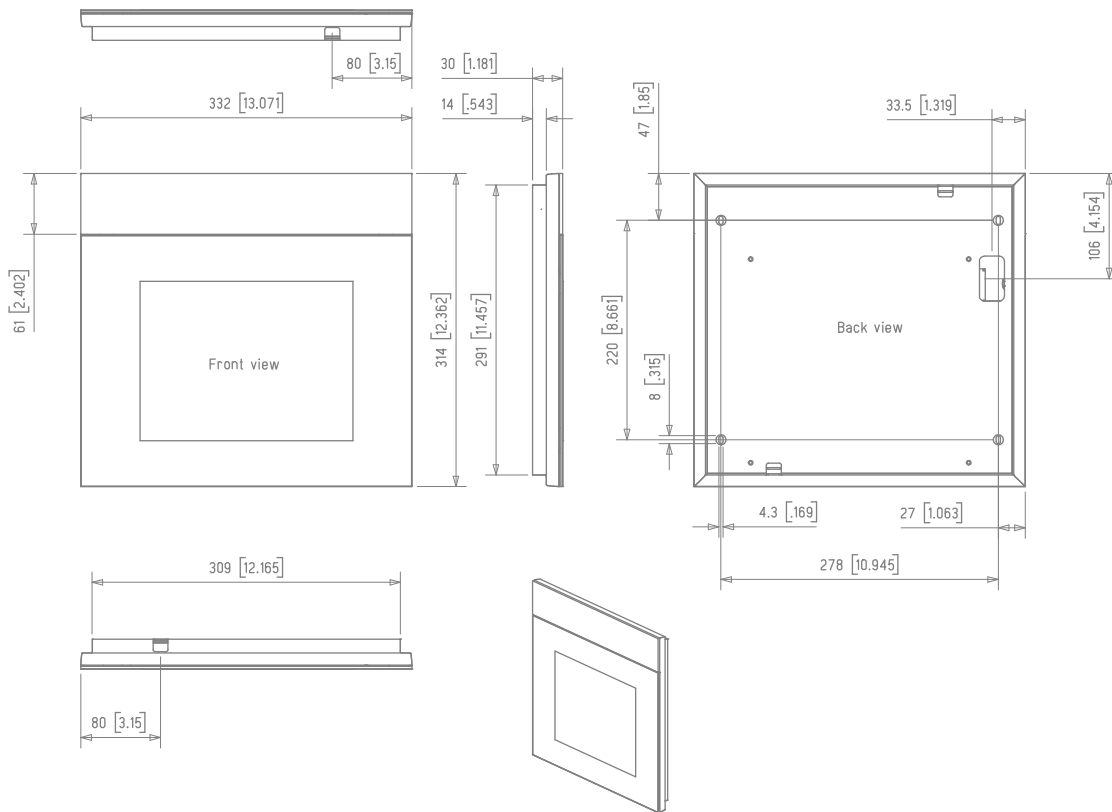

Built into wall (option - no extra parts needed):

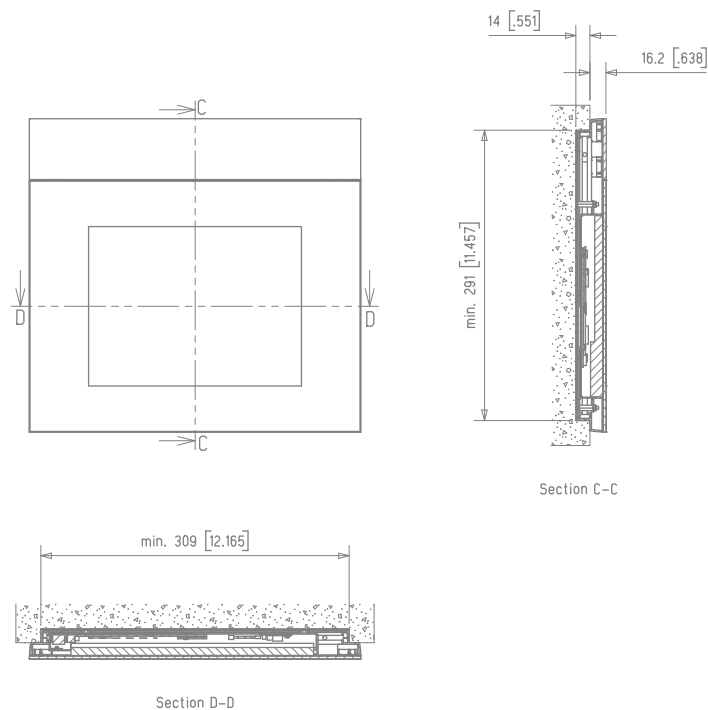

Ariadne Flat Front with Top and Bottom Panel

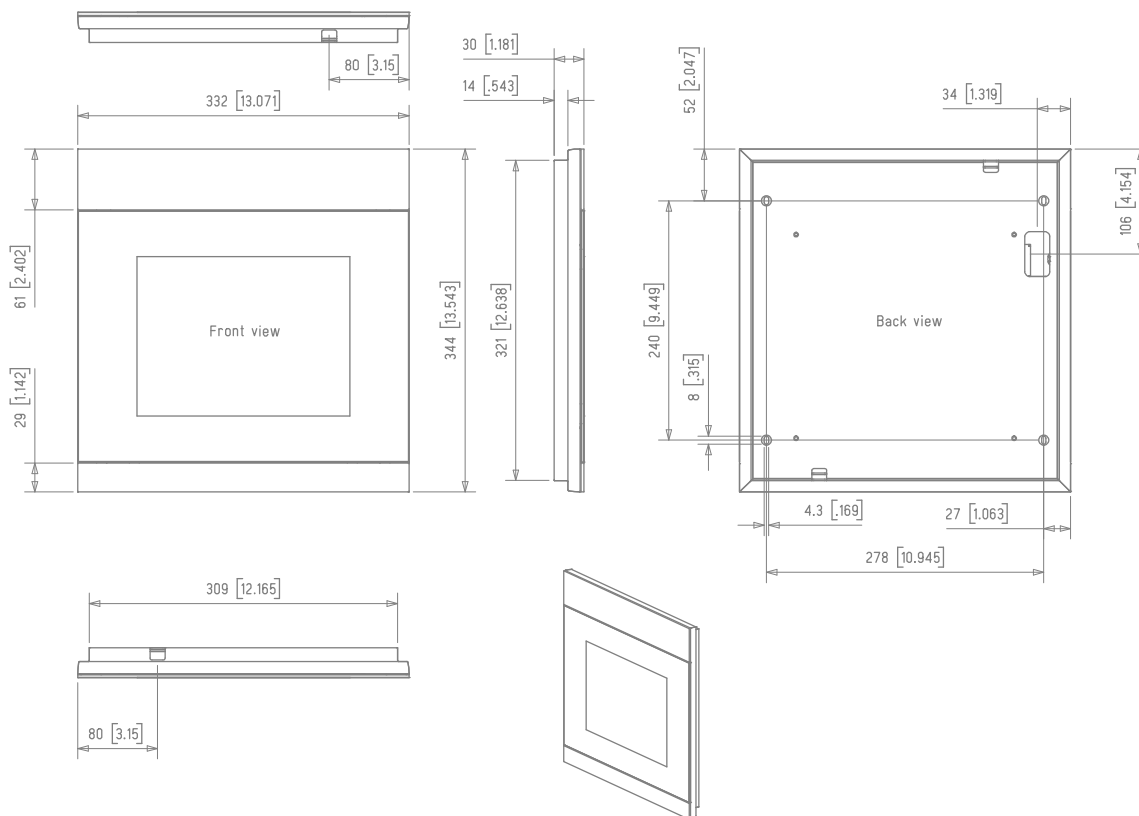

Built into wall (option - no extra parts needed):

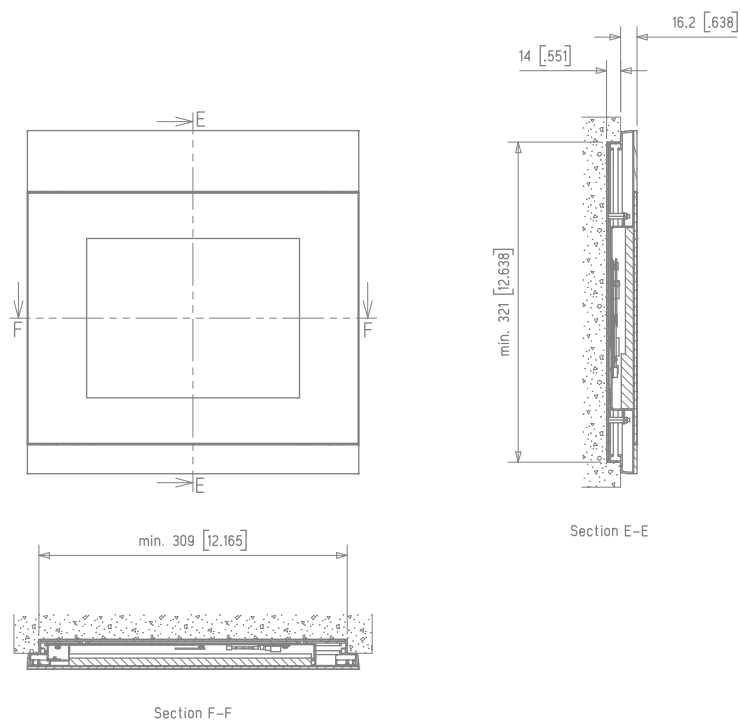

Wiring Details for 10" Wall Sign

The power supply and the smart box are placed outside the sign. The purpose of the smart box is to combine power and network signal into one cable so that you only need one cable in connection with the sign. This cable can enter the sign through holes in the cabinet as shown in the pictures below. The below technical drawings also show:

- Exact position of the inlet holes
- Length of cables measured from point of entrance (cable inlet) to the end of the cable/outlet

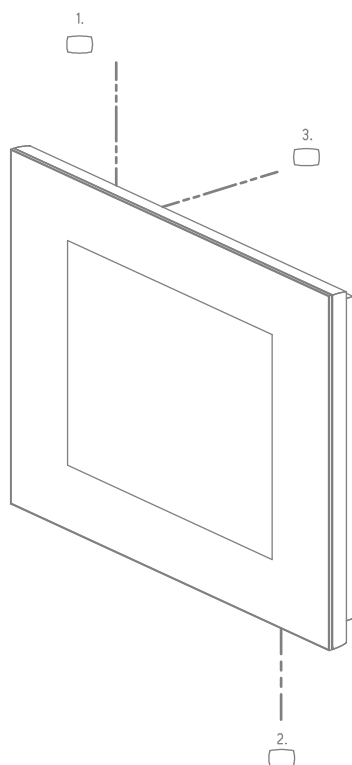

Length of cables:

Cable inlet option	Flat front	Flat front w. top panel	Flat front w. top/bottom panel
1	100mm [3.94]	160mm [6.30]	160mm [6.30]
2	575mm [22.64]	575mm [22.64]	605mm [23.81]
3	25mm [0.98]	25mm [0.98]	25mm [0.98]

Wiring Diagram:

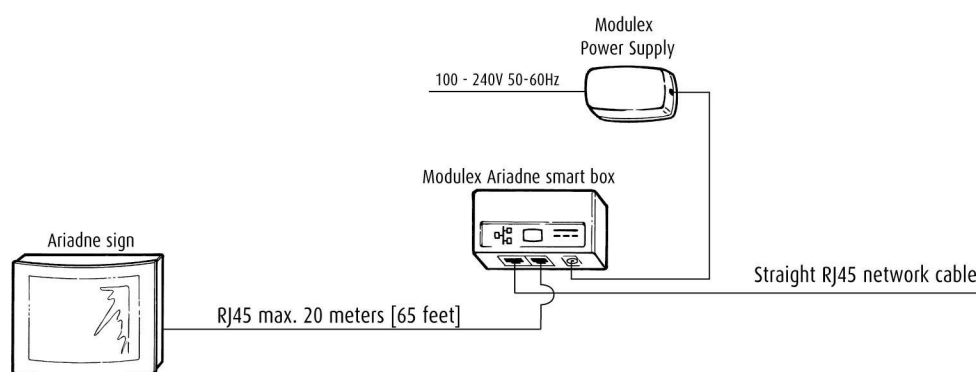

Ethernet cable specification (between network and smart box): Standard straight RJ45

Ethernet cable specification (between sign and smart box): Standard straight RJ45 max. 20m [65 ft.]

Ethernet pin configuration:

RJ45 straight: Use standard T568A in both ends OR standard T568B in both ends.

T568A pin colours: 1=white/green, 2=green, 3=white/orange, 4=blue, 5=white/blue, 6=orange, 7=white/brown, 8=brown

T568B pin colours: 1=white/orange, 2=orange, 3=white/green, 4=blue, 5=white/blue, 6=green, 7=white/brown, 8=brown

12V power supply and cable specification:

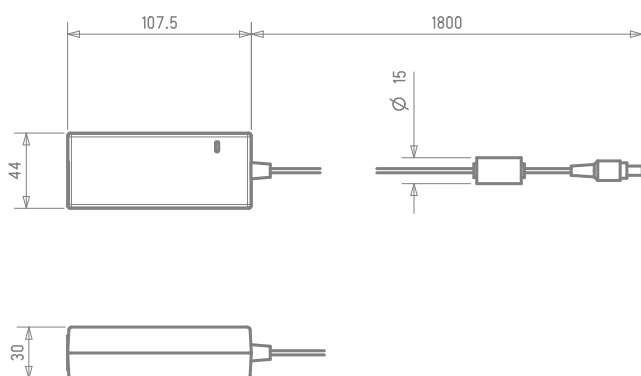

Power Supply is delivered with 1.8m cable. 2.5 m extension cable can be ordered separately. Max. 1 extension cable can be used. The temperature of the surroundings must not exceed 40 degrees Celsius and the heat dissipation conditions must not be bad.

The Power Supply is available in European and American version. To be ordered separately.

Power cable:

Power Supply is delivered with power cable inclusive of plug.

Smart box:

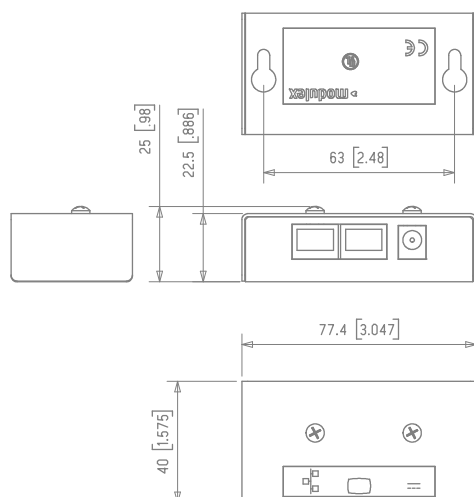

Electrical specifications:

Please see the “sign approval” label below

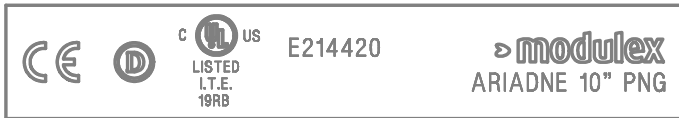
**Weight of Components**

Smart box:	0.1 kg	0.2 lb
Power supply:	0.3 kg	0.7 lb

Sign weight (excl. smart box and power supply):

Flat wall:		
10\" PNG	2.2 kg	4.8 lb
10\" PNG w. top panel	2.4 kg	5.4 lb
10\" PNG w. top/bottom panel	2.6 kg	5.7 lb

Mounting Details

The cable must be pulled into the sign before fixing the sign to the wall.

Guideline for mounting height: Place top of display 1700mm [66.9in] above the floor.

Service and Maintenance

Dismounting:

Panels and flat glass are removed by pulling them perpendicular to the panel surface

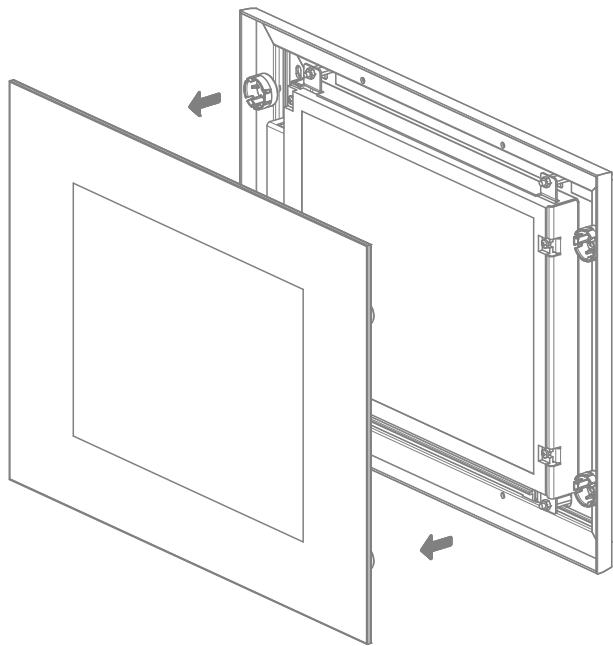

Cleaning:

When necessary the construction must be dismantled and cleaned with a vacuum cleaner.

Painted surfaces: Use a soft cloth moistened with a mild window detergent.

Displays (polarizers): Use absorbent cotton or a soft cloth.

The desirable cleaners are water, IPA (Isopropyl Alcohol) or Hexane.

Do not use Ketone type materials (eg. Acetone), Ethyl alcohol, Toluene, Ethyl acid or Methyl chloride.

It might cause permanent damage to the polarizer due to chemical reaction.